

AIR CYLINDER

Series A63, A64

Cat No A63, A64 - 01 - 02 - C

Double Acting Cylinders (Compact ISO type) Ø25 - 100 mm

As per ISO 21287 standards

Features

- Elastomer end cushioning
- Wide varieties of mountings
- Space saving
- Magnetic and Non magnetic version
- Aluminium profile (square) cylinder barrel
- Magnetic sensor common for all sizes
(Refer Magnetic sensor catalogue)

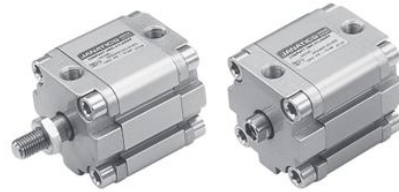

Technical Specifications

Cylinder bore Ø (mm)	25	32	40	50	63	80	100
Standard strokes * (mm)	5, 10, 15, 20, 25, 30, 40, 50, 60	10, 15, 20, 25, 30, 40, 50, 60, 70, 80					
Medium	Compressed air - filtered - lubricated						
Working pressure range	0.5 - 10 bar						
Medium temperature	5° - 60° c						
Materials of construction	Aluminium, Nitrile, Steel, Polyurethane						
Mountings ®	Basic cylinder, Foot mounting, Front flange, Rear flange, Male clevis, Female clevis,						
Accessories #	Clevis foot bracket, Wall mounting bracket, Rod end fork, Rod end aligner, Rod end spherical eye						

* For Non standard or longer stroke cylinders, contact your regional dealer or **JANATICS**

® Ø25mm Female clevis not available.

Ø25mm Clevis foot bracket and Wall mounting bracket not available.

Output force (force in N : 1N = 0.1 kgf)

Cylinder bore Ø (in mm)	Rod Ø (in mm)		Working pressure in bar								
			2	3	4	5	6	7	8	9	10
25	10	Extend	88	132	176	220	264	308	352	396	440
		Retract	74	111	148	185	222	260	296	334	370
32	12	Extend	145	217	289	362	434	507	579	651	724
		Retract	124	187	249	311	373	435	498	559	622
40	12	Extend	226	339	452	565	678	792	905	1018	1130
		Retract	206	309	411	514	617	720	823	926	1029
50	16	Extend	353	530	707	883	1060	1237	1413	1590	1767
		Retract	317	476	634	793	952	1110	1269	1427	1586
63	16	Extend	561	842	1122	1403	1683	1964	2244	2525	2805
		Retract	525	787	1050	1312	1575	1837	2099	2362	2624
80	20	Extend	905	1357	1809	2262	2714	3167	3619	4071	4524
		Retract	848	1272	1696	2120	2544	2969	3393	3817	4241
100	20	Extend	1414	2120	2827	3534	4241	4948	5655	6362	7068
		Retract	1357	2036	2714	3393	4071	4750	5429	6107	6786

(Above values have been worked out taking frictional loss into consideration)

AIR CYLINDER

Series A63, A64

Cat No A63, A64 - 01 - 02 - C

Basic cylinder

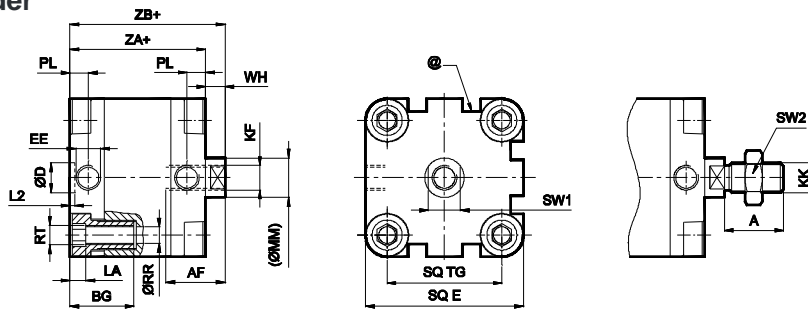

+ Add stroke

Cylinder bore Ø	KF	MM	AF	RR min	RT	SW1	PL	LA	BG min	EE	TG	E max	D H10	L2	ZA	Tol	ZB	Tol	WH	Tol	KK	A -0.5	SW2	Stroke tol
25	M6x1	10	10	4.1	M5	9	6	6	5	M5x0.8	26	40	9	2	39	±0.5	45	±1.4	6	±1.4	M8x1.25	16	13	+ 2 0
32	M8x1.25	12	12	5.1	M6	10	7.5	5.5	15	G1/8	32.5	45	10	2	44	±0.7	51	±1.6	7	±1.6	M10x1.25	19	17	
40	M8x1.25	12	12	5.1	M6	10	7.5	5.5	15	G1/8	38	51	10	2	45		52		7		M10x1.25	19	17	
50	M10x1.5	16	16	6.4	M8	13	7.5	5.5	16	G1/8	46.5	64	12	2	45		53		8		M12x1.25	22	19	
63	M10x1.5	16	16	6.4	M8	13	7.5	5.5	16	G1/8	56.5	74	12	2	49	±0.8	57	±2	8	±2	M12x1.25	22	19	+ 2.5 0
80	M12x1.75	20	20	8.4	M10	17	8	5.5	17	G1/8	72	94	12	2	54		64		10		M16x1.5	28	24	
100	M12x1.75	20	20	8.4	M10	17	12.5	5.5	17	G1/8	89	111	12	3	67		77		10		M16x1.5	28	24	

@ - T Groove for magnetic sensor, Refer catalogue series AM4

Foot mounting

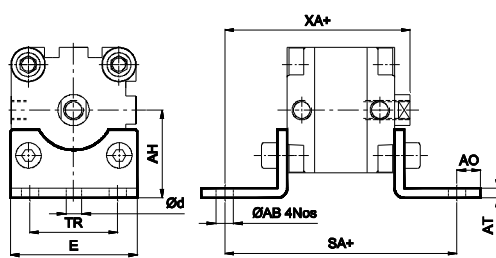

+ Add stroke

Cylinder bore Ø	AB H14	AO max	AT	AH JS16	d*	TR JS14	E	SA	Tol	XA	Tol	Recommended Bolt size	Ordering no.
25	7	6	4	29	5.8	26	40	71	±1.25	61	±1.25	M6	ML2025
32	7	7	4	33.5	5.8	32	46	76		67			ML2032
40	10	9	4	38	7.8	36	52	81		70			M8
50	10	9	5	45	7.8	45	65	87	74	ML2050			
63	10	9	5	50	7.8	50	75	91	78	ML2063			
80	12	11	6	63	9.8	63	95	106	±1.6	90	±1.6	M10	ML2080
100	14.5	13	6	74	11.8	75	115	121		104		M12	ML2100

* Suitable for reaming

Front flange

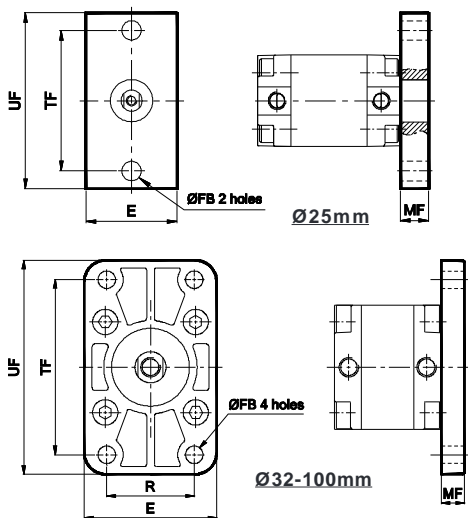

+ Add stroke

Cylinder bore Ø	MF	UF	TF ±0.3	R ±0.3	E	FB H13	ØD H11	Recommended Bolt size	Ordering no.
25	8	76	60	-	40	6.6	16	M6	MF2025
32	10	80	64	32	50	7			MF1032
40	10	90	72	36	55	9	-	M8	MF1040
50	12	110	90	45	68	9			MF1050
63	12	125	100	50	78	9			MF1063
80	16	155	126	63	100	12	-	M10	MF1080
100	16	185	150	75	120	14			M12

AIR CYLINDER

Series A63, A64

Cat No A63, A64 - 01 - 02 - C

Rear flange

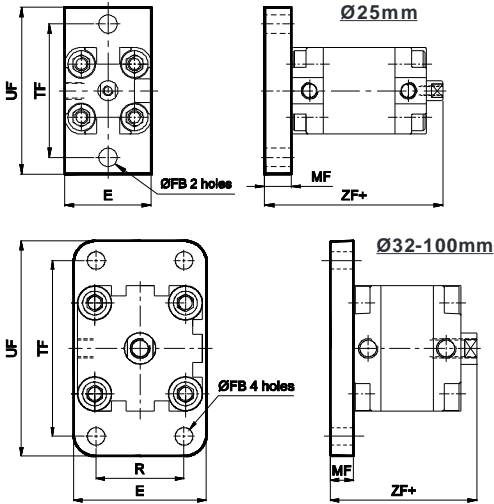

+ Add stroke

Cylinder bore Ø	MF	UF	TF ±0.3	R ±0.3	E	FB H13	ZF	Tol	Recommended Bolt size	Ordering no.
25	8	76	60	-	40	6.6	53	±1.5	M6	MF2025
32	10	80	64	32	50	7	61	±1.8		MF1032
40	10	90	72	36	55	9	62		M8	MF1040
50	12	110	90	45	68	9	65			MF1050
63	12	125	100	50	78	9	69	M10	M12	MF1063
80	16	155	126	63	100	12	80			MF1080
100	16	185	150	75	120	14	93	±2.2	MF1100	

Male clevis

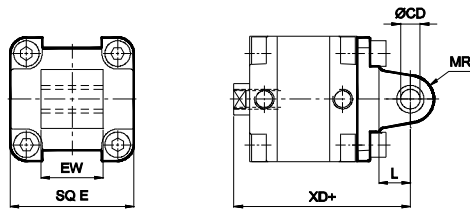

+ Add stroke

Cylinder bore Ø	CD H9	EW	Tol	L	MR	E max	XD	Tol	Ordering no.
25	8	16	-0.2 -0.6	12	9	40	65	±1.6	MS2025
32	10	26		12	11	45	73		±1.8
40	12	28		15	13	51	77	MS1040	
50	12	32		15	13	64	80	MS1050	
63	16	40		20	17	74	89	±2.2	MS1063
80	16	50		20	17	94	100		MS1080
100	20	60		25	21	111	118	MS1100	

Female clevis

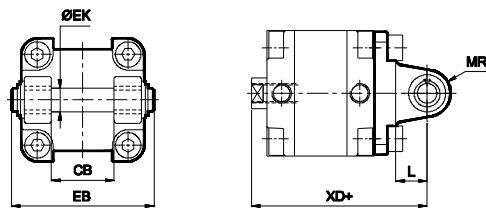

+ Add stroke

Cylinder bore Ø	EK e8	CB H14	L	MR	EB max	XD	Tol	Ordering no.
32	10	26	12	11	56	73	±1.8	MD1032
40	12	28	15	13	65	77		MD1040
50	12	32	15	13	73	80		MD1050
63	16	40	20	17	86	89		MD1063
80	16	50	20	17	106	100	±2.2	MD1080
100	20	60	25	21	129	118		MD1100

Accessories for Air Cylinder series A63, A64

Clevis foot bracket

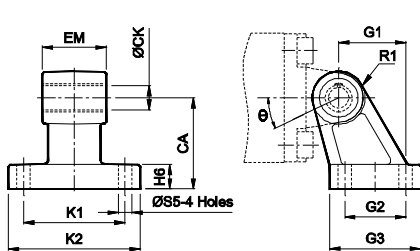

Cylinder bore Ø	K1 Js14	G2 Js14	S5 H13	CA Js15	CK H9	EM	Tol	G1 Js14	H6	R1 max	K2	G3	θ°	Recommended Bolt size	Ordering no. @
32	38	18	6.6	32	10	26	-0.2 -0.6	21	8	10	51	31	10	M6	AA1032
40	41	22	6.6	36	12	28		24	10	11	54	35	15	M6	AA1040
50	50	30	9	45	12	32		33	12	13	65	45	15	M8	AA1050
63	52	35	9	50	16	40		37	12	15	67	50	15	M8	AA1063
80	66	40	11	63	16	50		47	14	15	86	60	15	M10	AA1080
100	76	50	11	71	20	60		55	15	19	96	70	15	M10	AA1100

@ Adoptable to cylinder with female clevis

AIR CYLINDER

Series A63, A64

Cat No A63, A64 - 01 - 02 - C

Clevis foot bracket (with spherical bearing)

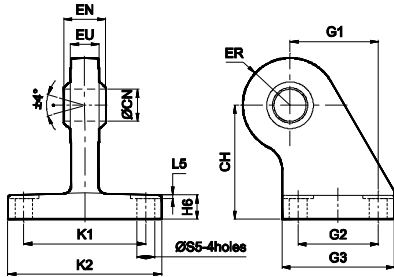

Cylinder bore Ø	K1 Js14	G2 Js14	S5 H13	CH Js15	CN H7	EU max	G1 Js14	H6	ER max	K2 max	G3	EN -0.1	L5	Ordering no. @
32	38	18	6.6	32	10	10.5	21	10	16	51	31	14	1	AB1032
40	41	22	6.6	36	12	12	24	10	18	54	35	16	1	AB1040
50	50	30	9	45	16	15	33	12	21	65	45	21	1	AB1050
63	52	35	9	50	16	15	37	12	23	67	50	21	1	AB1063
80	66	40	11	63	20	18	47	14	28	86	60	25	2	AB1080
100	76	50	11	71	20	18	55	15	30	96	70	25	2	AB1100

@ Adoptable to cylinder with female clevis

Wall mounting bracket

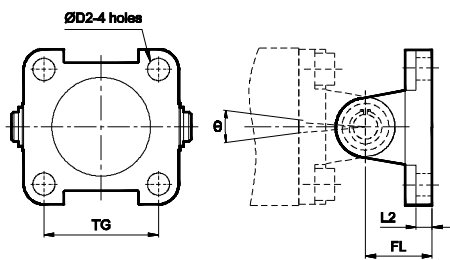

Cylinder bore Ø	TG	D2	L2	FL	θ°	Recommended Bolt size	Ordering no. @	Ordering no. #
32	32.5	6.6	5.5	22	90	M6	AV1032	AW1032
40	38	6.6	5.5	25	90	M6	AV1040	AW1040
50	46.5	9	6.5	27	90	M8	AV1050	AW1050
63	56.5	9	6.5	32	90	M8	AV1063	AW1063
80	72	11	10	36	60	M10	AV1080	AW1080
100	89	11	10	41	60	M10	AV1100	AW1100

@ Adoptable to cylinder with male clevis
Adoptable to cylinder with female clevis

Rod end Fork (ISO 8140)

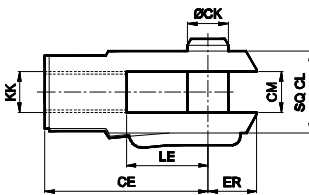

Cylinder bore Ø	KK	CE	CK f8	CM B12	LE	ER max	CL	Ordering no.
25	M8x1.25	32	8	8	16	13	16	AF008
32 / 40	M10x1.25	40	10	10	20	16	20	AF010
50 / 63	M12x1.25	48	12	12	24	19	24	AF012
80 / 100	M16x1.5	64	16	16	32	25	32	AF016

Rod end Aligner

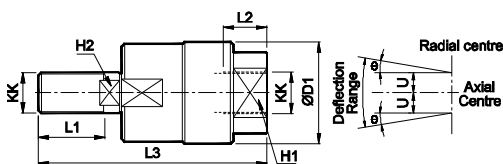

Cylinder bore Ø	KK	L1	L2	L3	H1	H2	D1	U	± θ°	Ordering no.
25	M8x1.25	15	10	48	12	7	20	0.75	5	AR008
32 / 40	M10x1.25	20	14	65	17	8	28	0.75	5	AR010
50 / 63	M12x1.25	22	18	75	19	10	32	1	5	AR012
80 / 100	M16x1.5	25	22	91	27	13	41	1	5	AR016

Rod end spherical eye (ISO 8139)

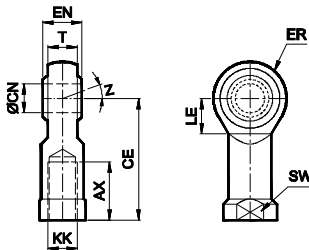

Cylinder bore Ø	KK	CN H9	T	EN h12	CE	LE min	ER max	AX	SW	Z	Ordering no.
25	M8x1.25	8	9	12	36	13	12	16	14		AP008
32 / 40	M10x1.25	10	10.5	14	43	15	14	20	17	13°	AP010
50 / 63	M12x1.25	12	12	16	50	17	16	22	19		AP012
80 / 100	M16x1.5	16	15	21	64	22	21	28	22	15°	AP016

AIR CYLINDER

Series A63, A64

Cat No A63, A64 - 01 - 02 - C

How to order

Model		Piston Ø (mm)		Stroke (mm)		Mountings		M - Male thread
63	Magnetic cylinder	025	- Ø 25	005	- 5	O	- Basic	
64	Standard cylinder	032	- Ø 32	010	- 10	L	- Foot Mounting	
		040	- Ø 40	015	- 15	F	- Front Flange	
		050	- Ø 50	020	- 20	R	- Rear Flange	
		063	- Ø 63	025	- 25	S	- Male Clevis	
		080	- Ø 80	030	- 30	D	- Female Clevis®	
		100	- Ø 100	040	- 40			
				050	- 50			
				060	- 60			
				070	- 70			
				080	- 80			

® Ø25mm Female clevis not available.

Note

For details of Accessories for Magnetic sensor, refer catalogue **Series AM4** (Page no. 1a.1.1)

Example:

Ordering no. for standard cylinder with 40 dia bore, 50 mm stroke with Female thread : **A64 040 050 O**

Ordering no. for standard cylinder with 40 dia bore, 50 mm stroke with Male thread : **A64 040 050 O - M**





Note:

If ordered as 40 dia, 50 mm stroke cylinder, Basic cylinder **A64 040 050 O** will be supplied.

For repeat order when the details are taken from cylinder nameplate, mention the mounting style separately.

For ordering **Accessories** refer corresponding tables for part numbers.

For ordering individual **Mounting kits** (If needed separately) the order numbers are as below

Cylinder bore Ø	Foot mounting *	Front / Rear flange *	Male clevis *	Female clevis *
				
25	ML2025	MF2025	MS2025	-
32	ML2032	MF1032	MS1032	MD1032
40	ML2040	MF1040	MS1040	MD1040
50	ML2050	MF1050	MS1050	MD1050
63	ML2063	MF1063	MS1063	MD1063
80	ML2080	MF1080	MS1080	MD1080
100	ML2100	MF1100	MS1100	MD1100

* Supplied with 4nos. of screws

For your special requirements of cylinders or for further informations contact your regional dealer or **JANATICS**

Subject to change